

HFA100MD60C

Ultrafast, Soft Recovery Diode

Features

- Reduced RFI and EMI
- Reduced Snubbing
- Extensive Characterization of Recovery Parameters

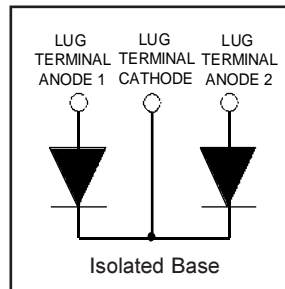

$V_R = 600V$
$V_F(\text{typ.})^{\textcircled{3}} = 1.1V$
$I_{F(AV)} = 100A$
$Q_{rr}(\text{typ.}) = 300nC$
$I_{RRM}(\text{typ.}) = 8A$
$t_{rr}(\text{typ.}) = 33ns$
$di_{(rec)M}/dt(\text{typ.})^{\textcircled{3}} = 240A/\mu s$

Description

HEXFRED™ diodes are optimized to reduce losses and EMI/RFI in high frequency power conditioning systems. An extensive characterization of the recovery behavior for different values of current, temperature and di/dt simplifies the calculations of losses in the operating conditions. The softness of the recovery eliminates the need for a snubber in most applications. These devices are ideally suited for power converters, motors drives and other applications where switching losses are significant portion of the total losses.

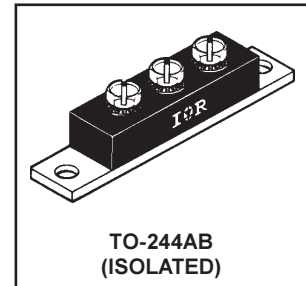

Absolute Maximum Ratings (per Leg)

	Parameter	Max.	Units
V_R	Cathode-to-Anode Voltage	600	V
$I_F @ T_C = 25^\circ C$	Continuous Forward Current	83	A
$I_F @ T_C = 100^\circ C$	Continuous Forward Current	40	
I_{FSM}	Single Pulse Forward Current ^①	400	
E_{AS}	Non-Repetitive Avalanche Energy ^②	220	μJ
$P_D @ T_C = 25^\circ C$	Maximum Power Dissipation	180	W
$P_D @ T_C = 100^\circ C$	Maximum Power Dissipation	71	
T_J T_{STG}	Operating Junction and Storage Temperature Range	-55 to +150	C

Thermal - Mechanical Characteristics

	Parameter	Min.	Typ.	Max.	Units
R_{thJC}	Junction-to-Case, Single Leg Conducting	—	—	0.70	$^\circ C/W$ K/W
	Junction-to-Case, Both Legs Conducting	—	—	0.35	
R_{thCS}	Case-to-Sink, Flat, Greased Surface	—	0.10	—	
Wt	Weight	—	79 (2.8)	—	g (oz)
	Mounting Torque ^④	30 (3.4)	—	40 (4.6)	lbf•in
	Terminal Torque	30 (3.4)	—	40 (4.6)	(N•m)
	Vertical Pull	—	—	80	lbf•in
	2 inch Lever Pull	—	—	35	

Note: ^① Limited by junction temperature
^② L = 100 μH , duty cycle limited by max T_J
^③ 125 $^\circ C$

^④ Mounting surface must be smooth, flat, free of burrs or other protrusions. Apply a thin even film of thermal grease to mounting surface. Gradually tighten each mounting bolt in 5-10 lbf•in steps until desired or maximum torque limits are reached. Module

HFA100MD60C

PD-2.442 rev. B 12/98

International
IOR Rectifier

Electrical Characteristics (per Leg) @ T_J = 25°C (unless otherwise specified)

Parameter	Min.	Typ.	Max.	Units	Test Conditions	
V _{BR}	600	—	—	V	I _R = 100μA	
V _{FM}	—	1.2	1.4	V	I _F = 50A	
	—	1.4	1.6		I _F = 100A	See Fig. 1
	—	1.1	1.3		I _F = 50A, T _J = 125°C	
I _{RM}	—	4.0	20	μA	V _R = V _R Rated	
	—	1.0	4.0	mA	T _J = 125°C, V _R = 480V	See Fig. 2
C _T	—	140	250	pF	V _R = 200V	See Fig. 3
L _S	—	7.0	—	nH	From top of terminal hole to mounting plane	

Dynamic Recovery Characteristics (per Leg) @ T_J = 25°C (unless otherwise specified)

Parameter	Min.	Typ.	Max.	Units	Test Conditions	
t _{rr}	—	33	—	ns	I _F = 1.0A, di _F /dt = 200A/μs, V _R = 30V	
t _{rr1}	—	76	115		T _J = 25°C	See Fig. 5
t _{rr2}	—	130	200		T _J = 125°C	
I _R RM1	—	8.0	15	A	T _J = 25°C	See Fig. 6
I _R RM2	—	12	22		T _J = 125°C	
Q _{rr1}	—	300	900	nC	T _J = 25°C	See Fig. 7
Q _{rr2}	—	780	2200		T _J = 125°C	
di _(rec) /dt1	—	340	—	A/μs	T _J = 25°C	See Fig. 8
di _(rec) /dt2	—	240	—		T _J = 125°C	

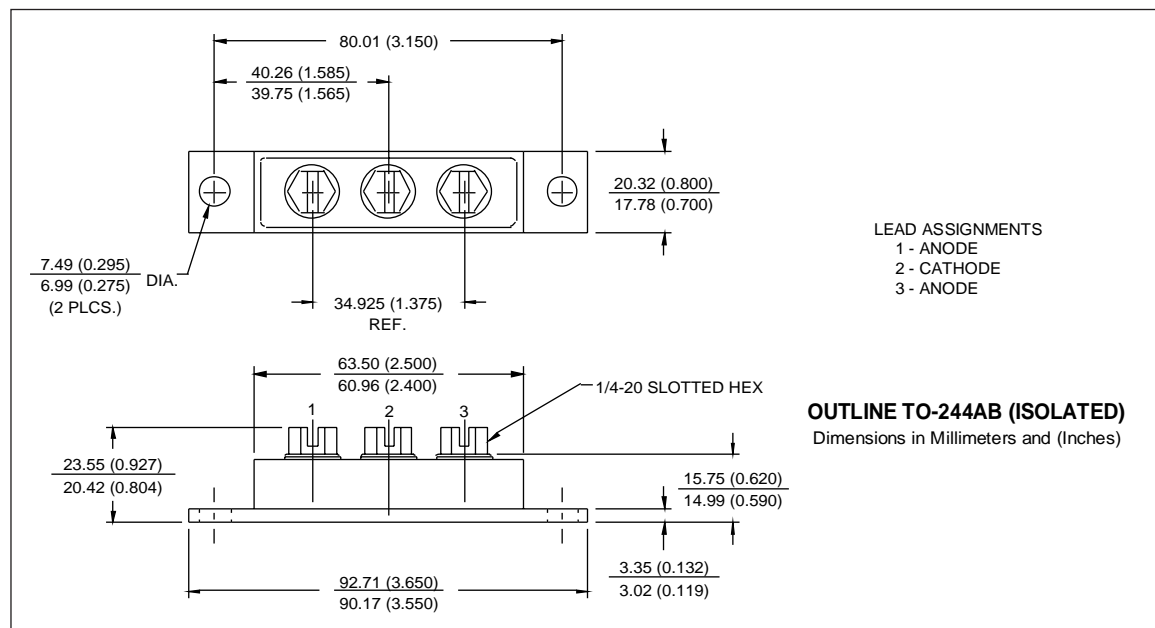

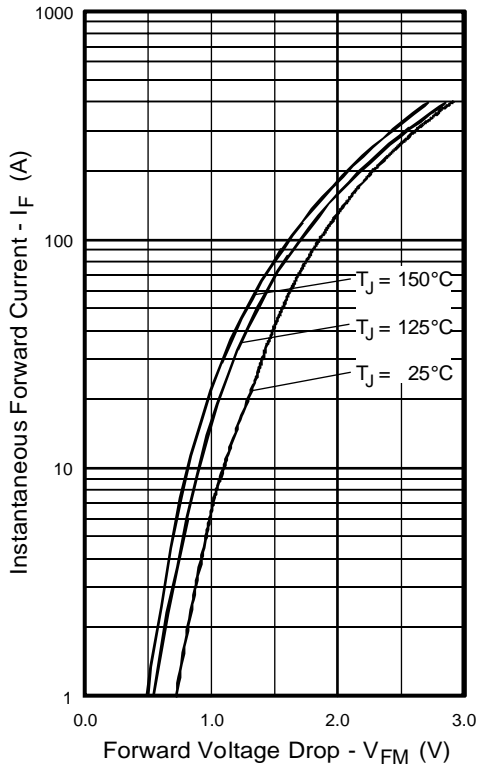

Fig. 1 - Maximum Forward Voltage Drop vs. Instantaneous Forward Current, (per Leg)

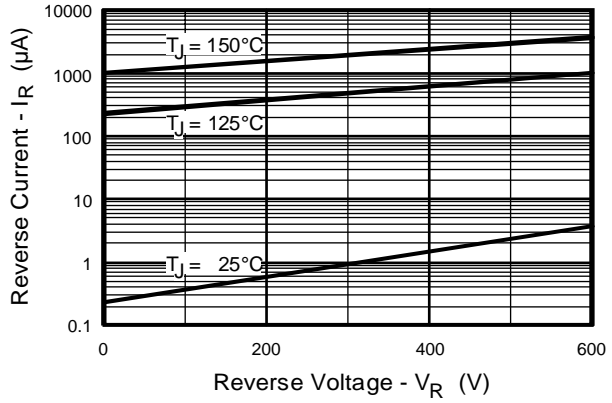

Fig. 2 - Typical Reverse Current vs. Reverse Voltage, (per Leg)

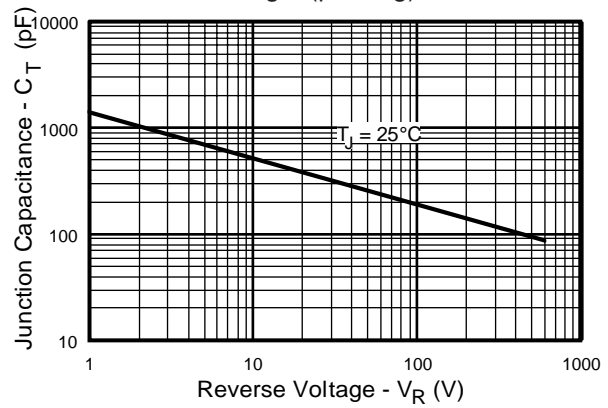

Fig. 3 - Typical Junction Capacitance vs. Reverse Voltage, (per Leg)

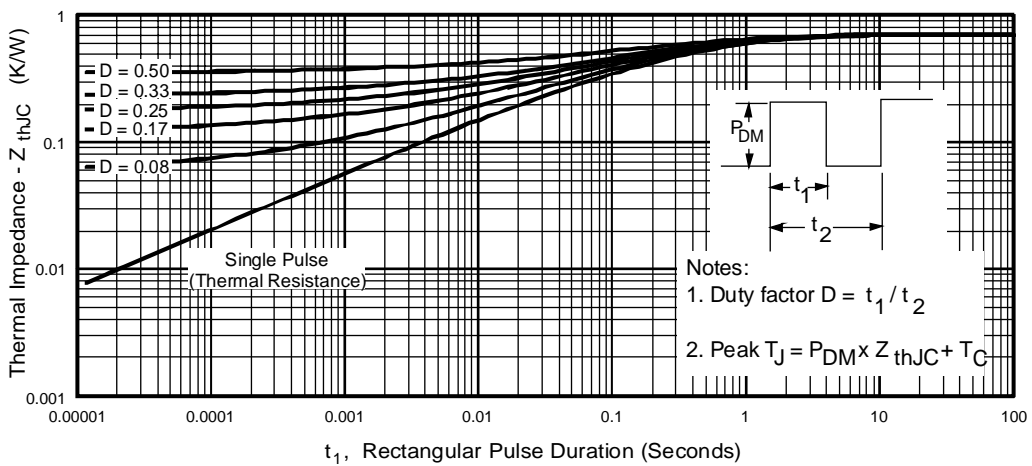

Fig. 4 - Maximum Thermal Impedance Z_{thJC} Characteristics, (per Leg)

HFA100MD60C

PD-2.442 rev. B 12/98

International
IOR Rectifier

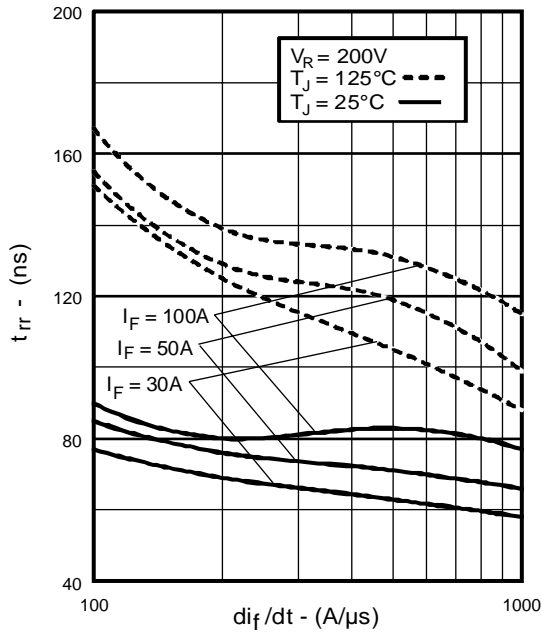

Fig. 5 - Typical Reverse Recovery vs. di_f/dt , (per Leg)

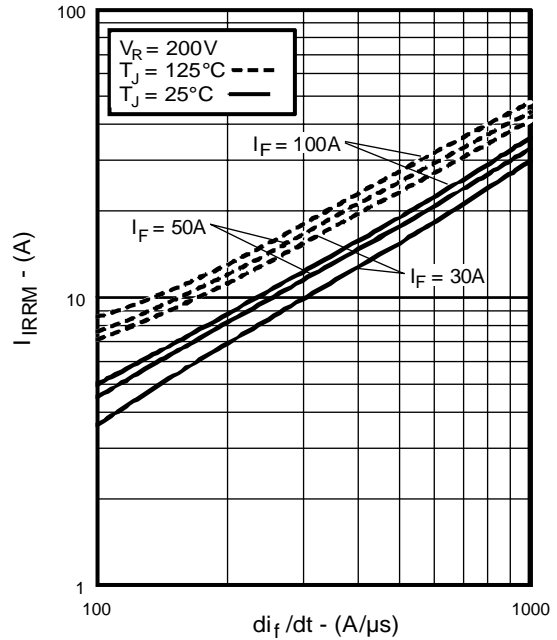

Fig. 6 - Typical Recovery Current vs. di_f/dt , (per Leg)

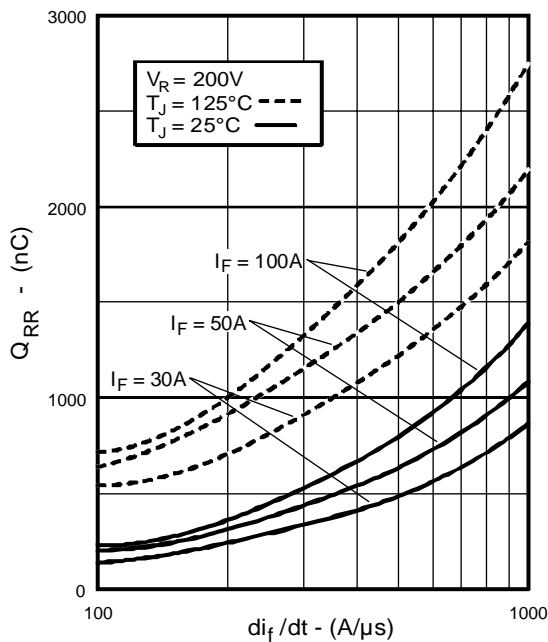

Fig. 7 - Typical Stored Charge vs. di_f/dt , (per Leg)

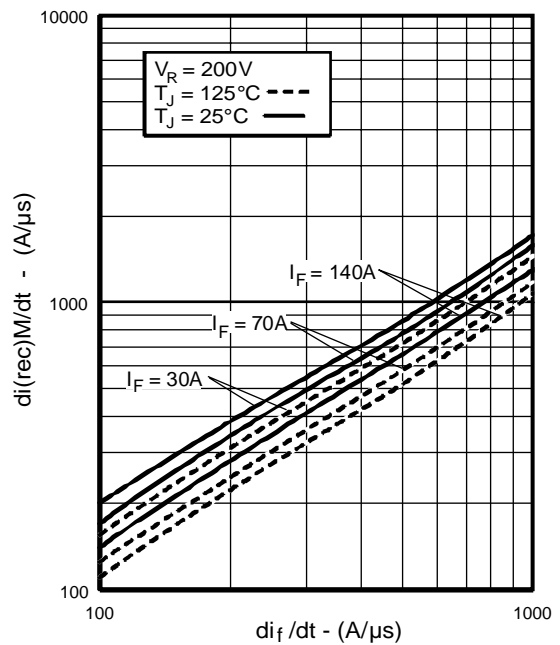

Fig. 8 - Typical $di(rec)M/dt$ vs. di_f/dt , (per Leg)

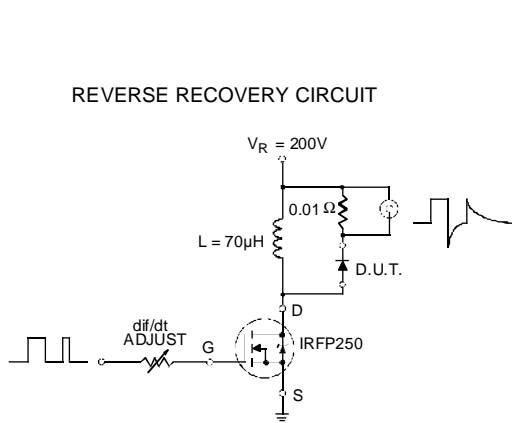

Fig. 9 - Reverse Recovery Parameter Test Circuit

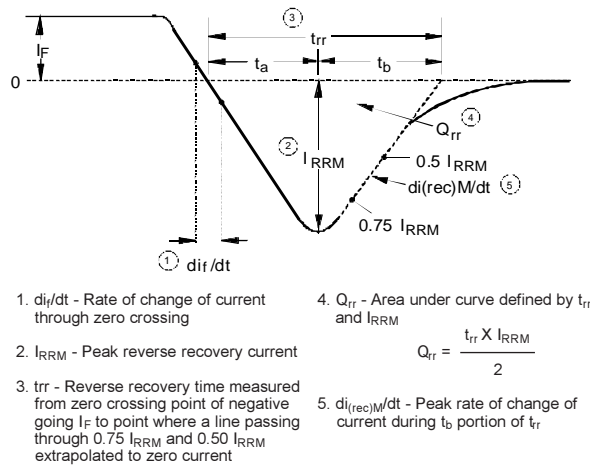

Fig. 10 - Reverse Recovery Waveform and Definitions

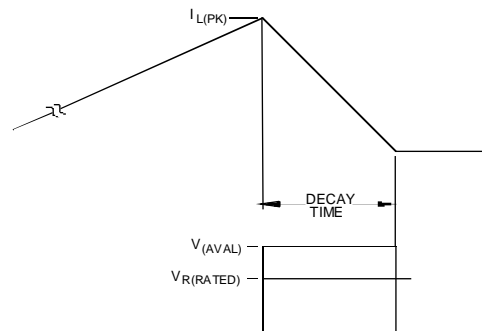
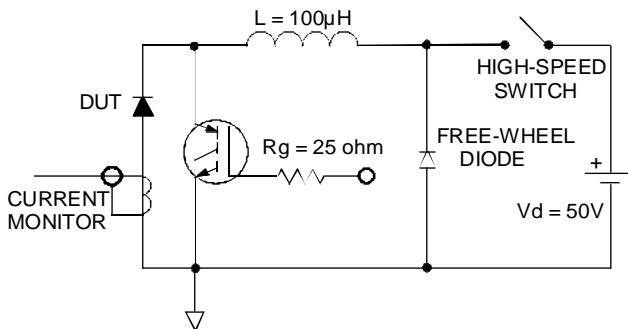

Fig. 11 - Avalanche Test Circuit and Waveforms